

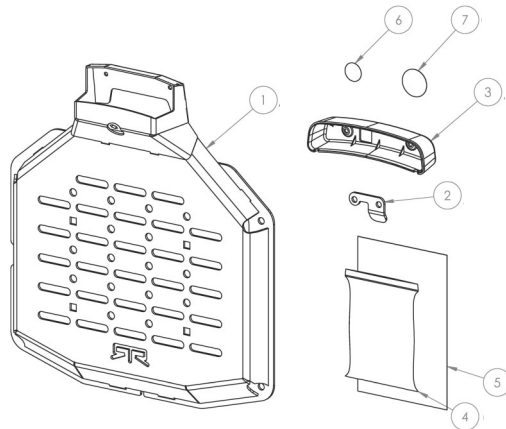

2021 Ford Bronco
RTR Tire Carrier Delete
Part number 14021.0017.99.B

Components Included

1	Delete Panel	1
2	Camera Bracket	1
3	Brake Light Housing	1
4	Hardware Pack	1
5	Instructions	1
6	Sealing Disc, Small	4
7	Sealing Disc, Large	2



NOTE: RTR advises the use of Loctite® Threadlocker Blue 242, or equivalent, on all threaded fasteners during assembly unless otherwise instructed.



1. With the vehicle parked on level ground remove the spare tire.

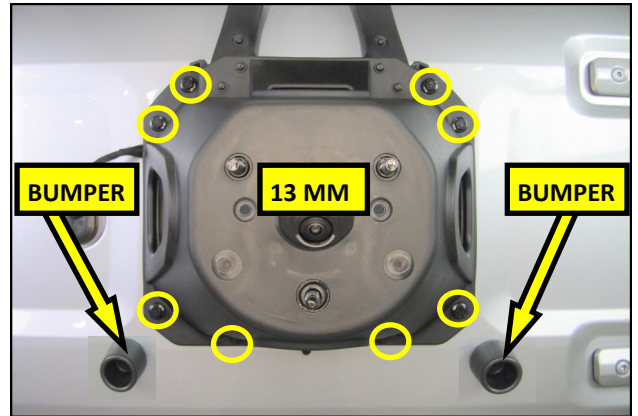

2. Using a plastic trim removal tool, pry the rubber bumpers out of the tailgate. Remove the eight bolts securing the OEM tire carrier to the vehicle and set them aside.

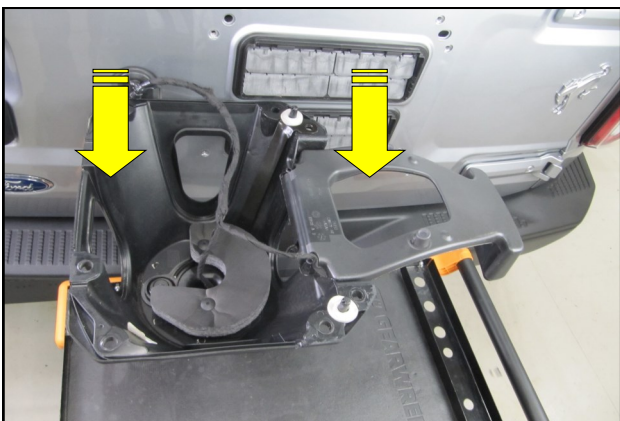

3. Set the tire carrier onto a tool cart or equivalent.

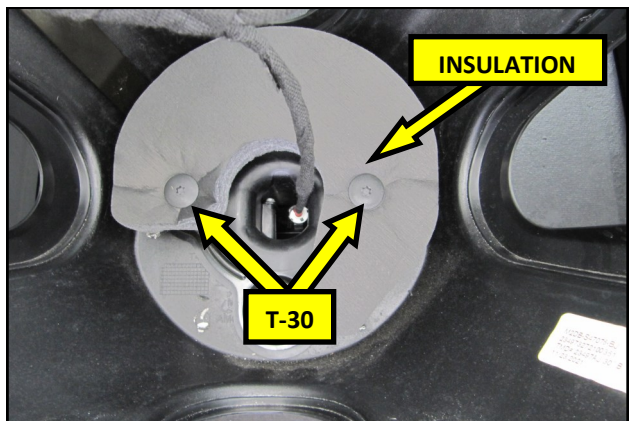

4. Using a T-30 TORX® driver, remove the two plastic fasteners in the insulation pad and remove the insulation from the tire carrier.

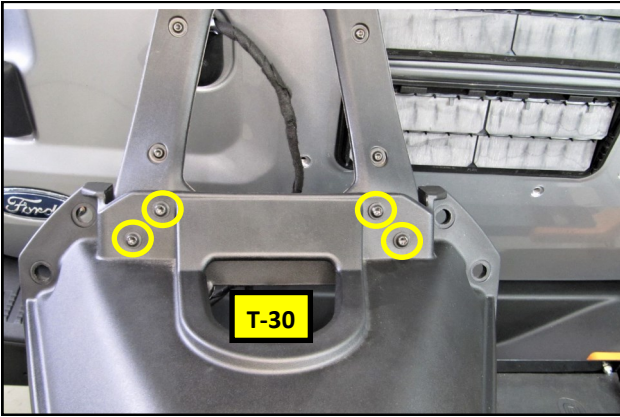

5. Using a T-30 TORX® driver, remove the four screws securing the third brake light to the tire carrier.

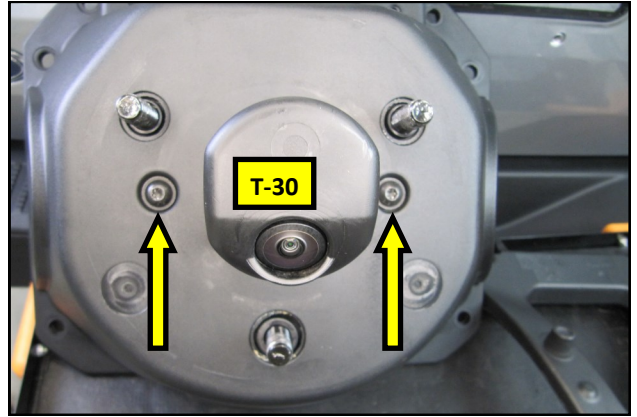

6. Using a T-30 TORX® driver, remove the two screws on the face of the tire carrier.

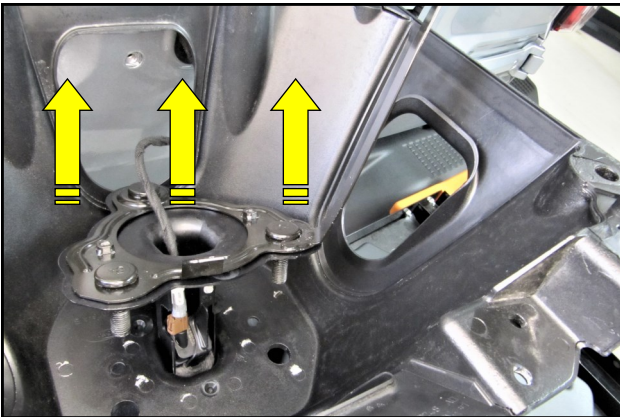

7. Remove the steel bracket and camera assembly from the tire carrier.

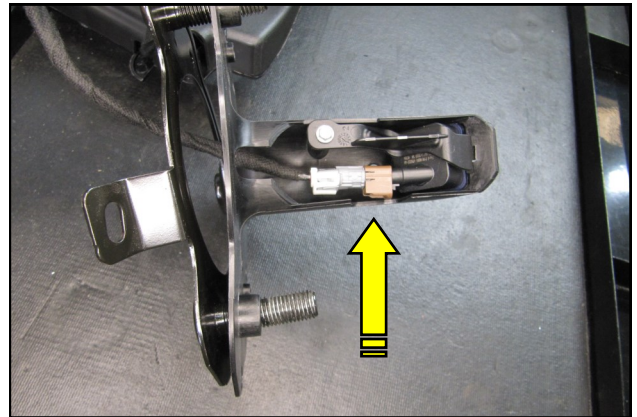

8. Disconnect the harness from the camera assembly and set it aside.

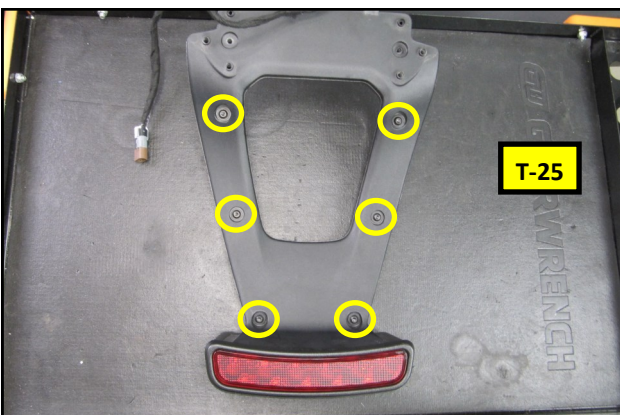

9. Using a T-25 TORX® driver, remove the six screws in the third brake light housing.

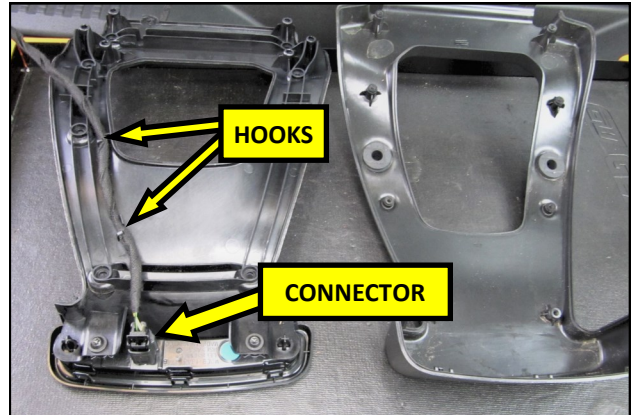

10. Separate the two halves of the housing to gain access to the light. Unhook and disconnect the wiring harness from the light.

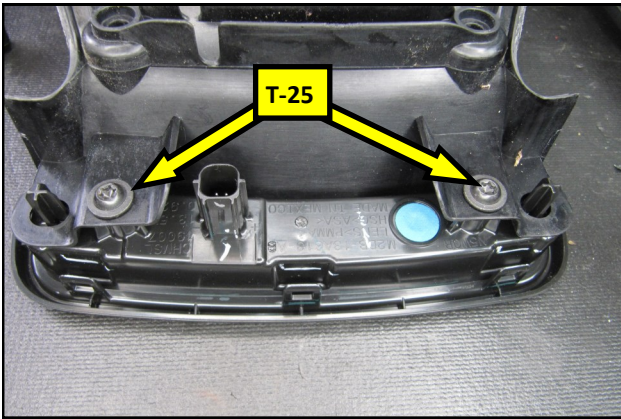

11. Using a T-25 TORX® driver, remove the two screws in the brake light bracket and remove the bracket.

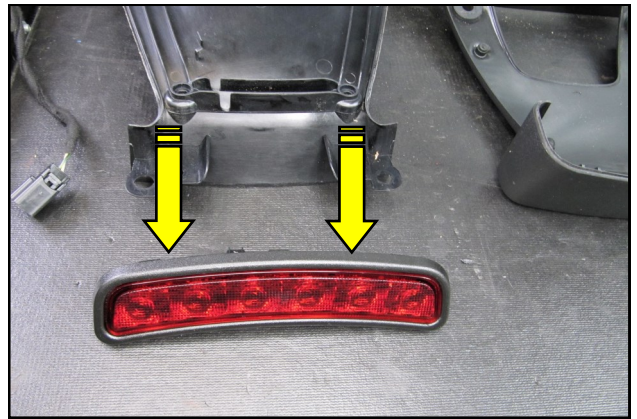

12. Remove the brake light from the housing and set it aside. This light will be reused with the RTR Tire Carrier Delete.

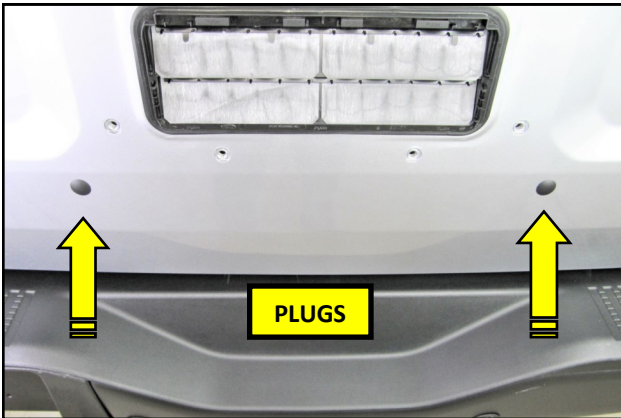

13. Insert the supplied Low Profile Plugs into the tailgate bumper holes in the from step 2.

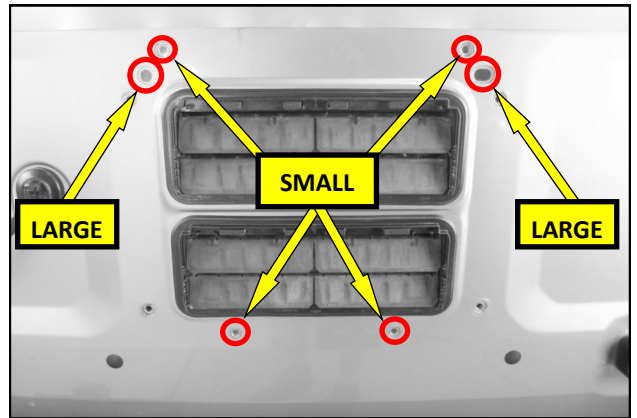

14. Using isopropyl alcohol, thoroughly clean the body surrounding the tire carrier bolt holes. Carefully apply the 2 large and 4 small Sealing Discs over the bolt holes as shown.

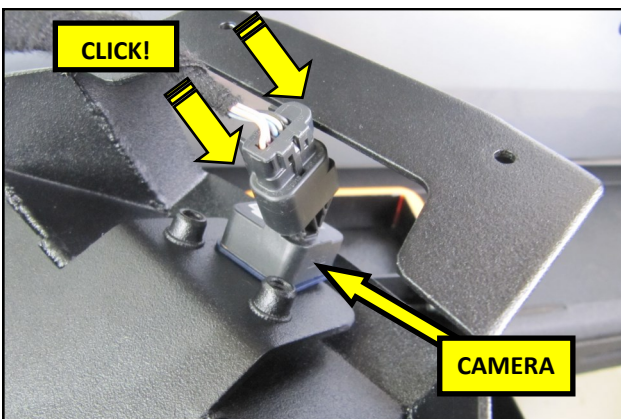

15. Transfer the OEM camera into the Tire Carrier Delete Panel and connect the wire harness.

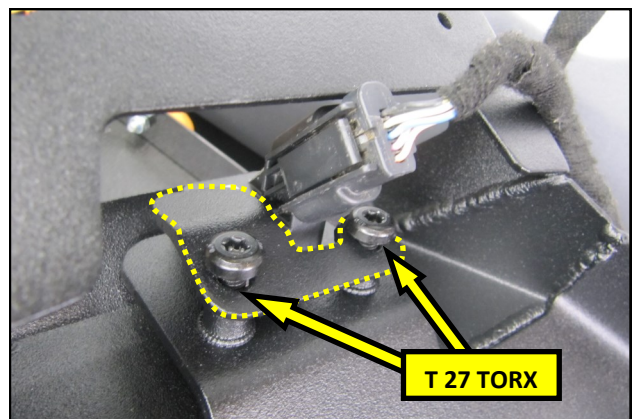

16. Secure the camera to the Delete Panel using the RTR Camera Bracket and the Supplied M6 Pan Head Bolts. **NOTE:** When properly installed, the Bolt heads will only have partial contact with the Camera Bracket.

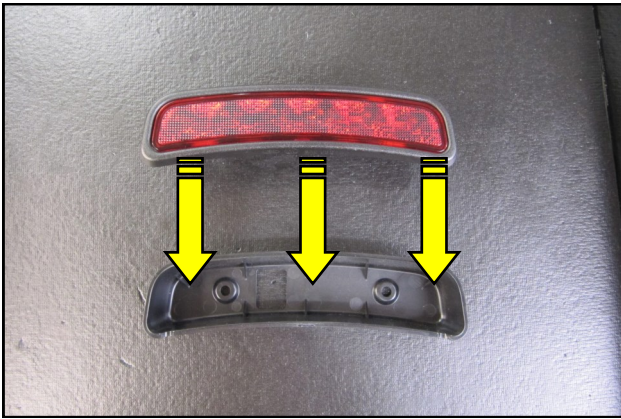

17. Transfer the brake light into the RTR Housing.

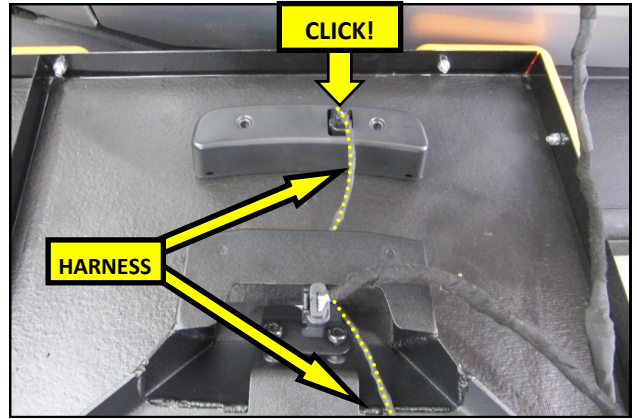

18. Feed the brake light harness through the Delete Panel as shown and Reconnect the brake light.

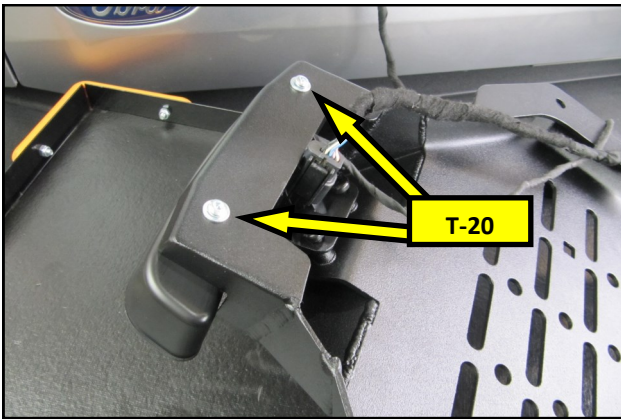

19. Secure the brake light assembly to the Delete Panel using the supplied Self Tapping Screws and Washers. Carefully tighten the Screws with a T-20 TORX® driver. Do not over tighten. Do not apply thread locker to these fasteners.

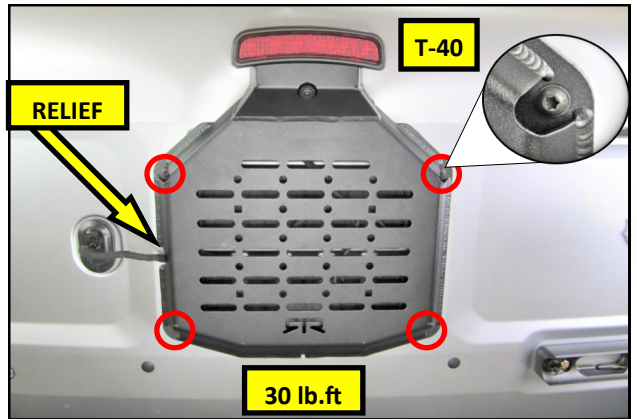

20. Secure the Delete Panel assembly to the vehicle using the supplied M8 Bolts and Washers. Using a T-40 TORX® driver, torque the bolts to 30 Lb.ft. When properly installed, the wiring harness will reside inside of the relief on the Panel.