

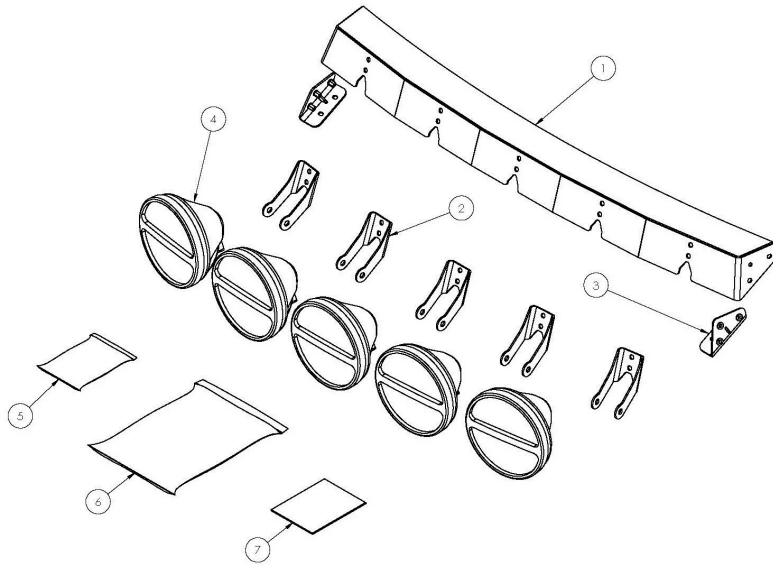

**2021-22 Ford Bronco**  
**RTR Light Bar**  
**Part Number 14041.0003.99.D**

**Components Included**

1.	Light Bar	1
2.	Light Bracket	5
3.	Roof Bracket	2
4.	Spot Lights	5
5.	Hardware Pack	1
6.	Instructions	1
7.	Wire Harness	1



**NOTE:** In addition to common hand tools, installation of the RTR Light Bar will require the use of a hand drill, 1/8 and 5/16" drill bits. A deburring tool and 6" torpedo level. A wire crimper, stripper, heat gun, emery cloth, electrical tape, and dielectric grease.

This RTR product is only intended to be installed on vehicles equipped with the OEM Auxiliary Switches in the Overhead Console.  
 This RTR product is not intended to be installed on vehicles equipped with the OEM Roof Rails with Crossbars.

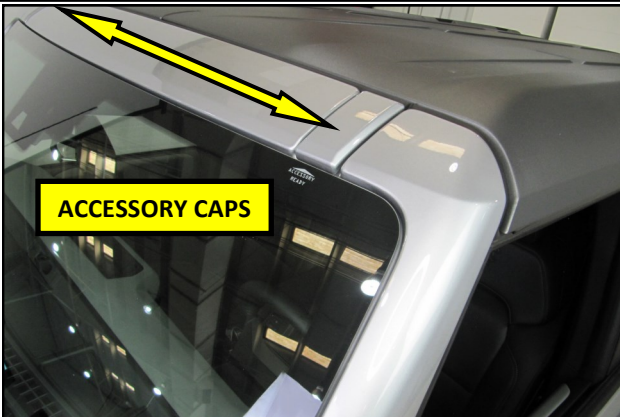

**1. Disconnect the Negative battery terminal.** Using a plastic trim removal tool, pry off both of the accessory caps and set them aside.

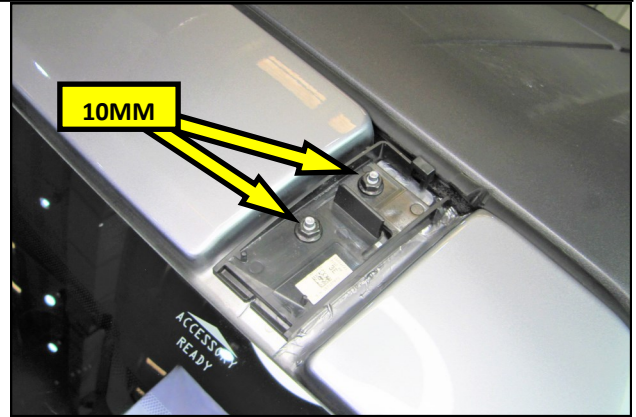

**2.** Using a 10 mm socket, remove the flange nuts securing the cap retainers to the vehicle. Retain the nuts for reuse.



**3.** Starting at the passenger side of the vehicle, Use a plastic trim removal tool to pry off the sun visor screw cover.



**4.** Rotate the screw cover to gain access to the visor screw. Using a 7 mm socket, remove the screw.



5. Release the sun visor from the roof and disconnect the wiring harness. Set the visor aside for now.



6. Using a pocket screwdriver, or equivalent, pry open the screw cover in the sun visor clip.

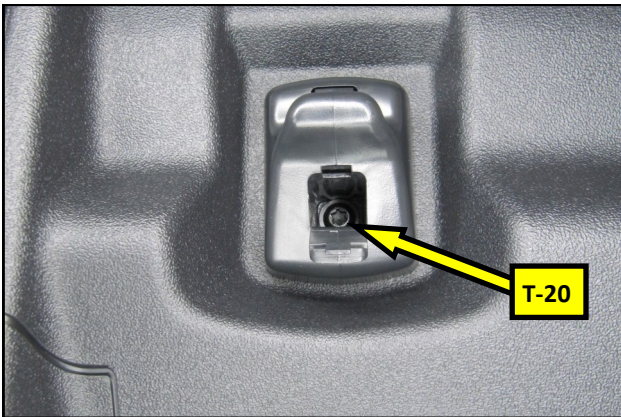

7. Using a T-20 TORX® driver remove the screw inside of the visor clip and remove the clip. Repeat steps 3-7 on the opposite side of the vehicle.

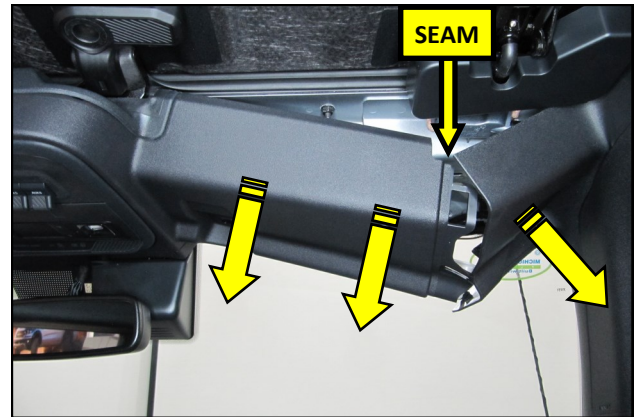

8. Starting at the panel seam, pull down and release the clips securing the windshield trim panels as shown.



9. Having all 4 panel clips released, unclip the wiring harness from the panel.

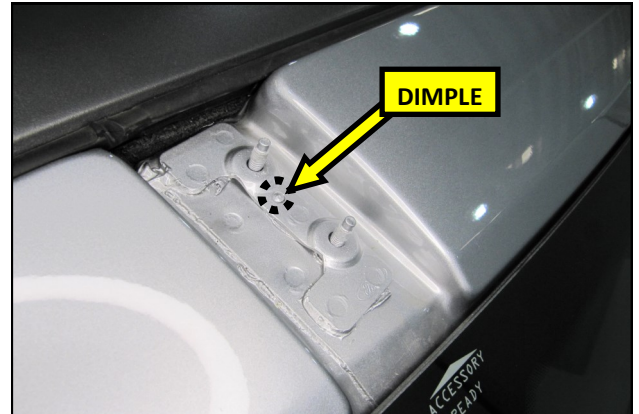

10. On the passenger side of the roof, locate the dimple between the accessory cap studs and drill a 1/8 " pilot hole.

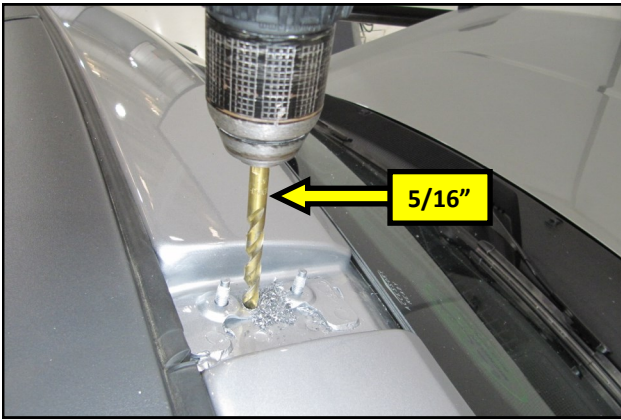

**11.** Using a 5/16" drill bit, enlarge the pilot hole in the roof.

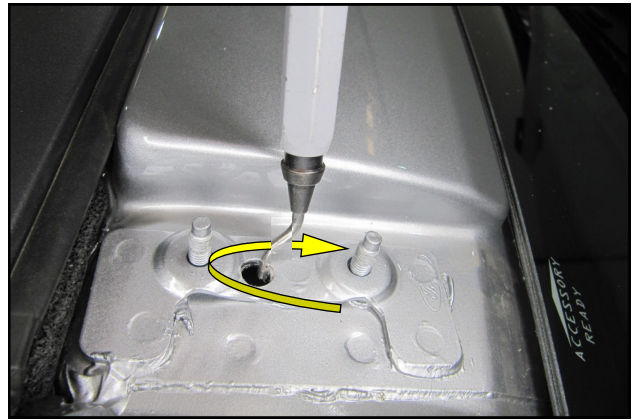

**12.** Using a deburring tool, remove all of the sharp edges in the sheet metal. Clear the hole of any remaining debris.

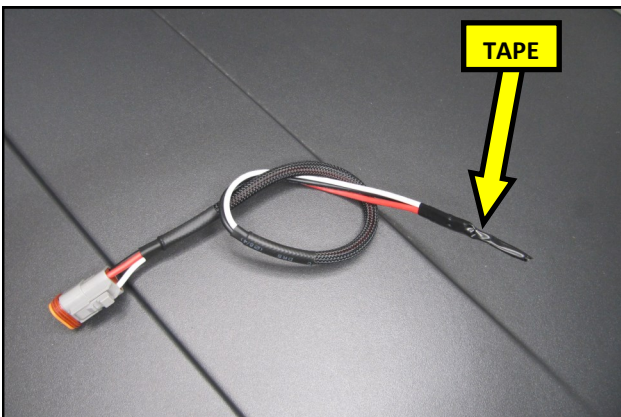

**13.** Tightly wrap the wires together at the end of the Pig Tail Harness.

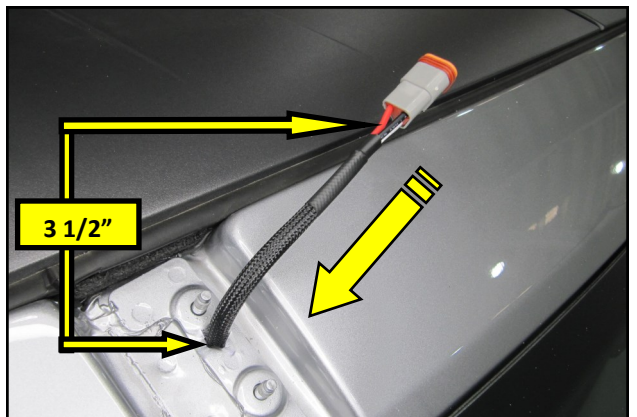

**14.** Insert the taped end of the Pig Tail into the hole drilled in step 11. Leave approximately 3 1/2" of the Pig Tail outside of the vehicle. Use the supplied silicone adhesive/ sealant to seal the hole drilled in step 12.

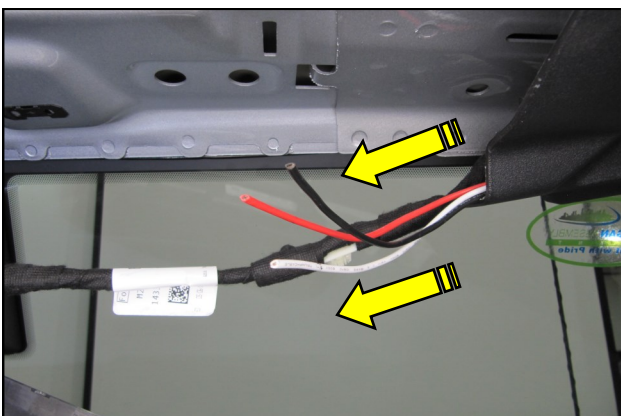

**15.** Pull the Pig Tail out from above the trim panel and remove the tape.

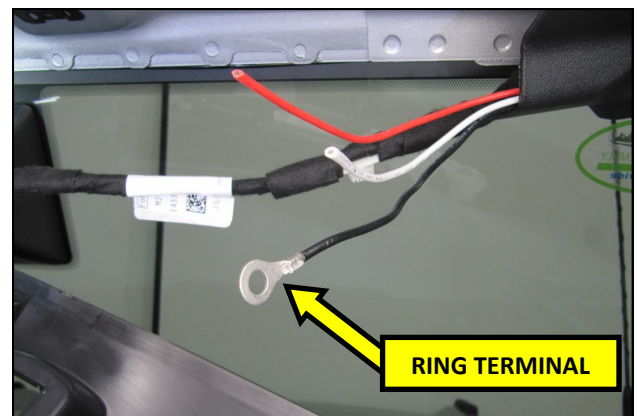

**16.** Strip approximately 3/16" of insulation from the Black wire and crimp the supplied Ring Terminal onto it.

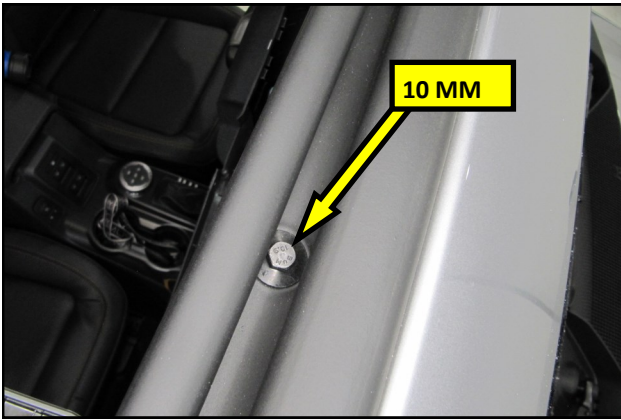

**17.** Fold the soft top back or remove the hard top panel above the passenger seat. Locate and remove the bolt and nut in the roof.

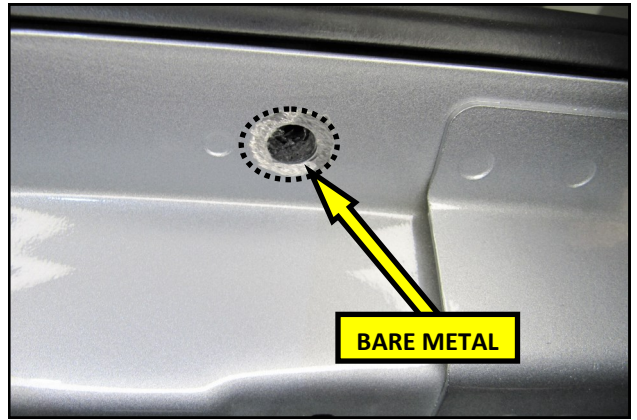

**18.** Using a small piece of emery cloth, remove the paint surrounding the bolt hole from step 17. Coat the bare metal with a thin layer of dielectric grease.

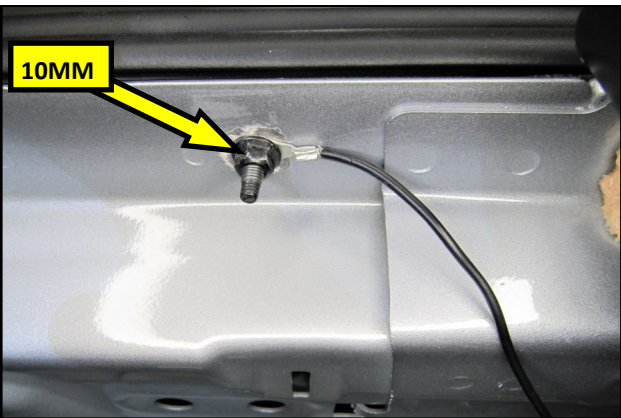

**19.** Reinstall the bolt from step 17. and slide the Ring Terminal on the black wire onto it. Secure the Ring Terminal using the OEM nut. Do not over tighten.

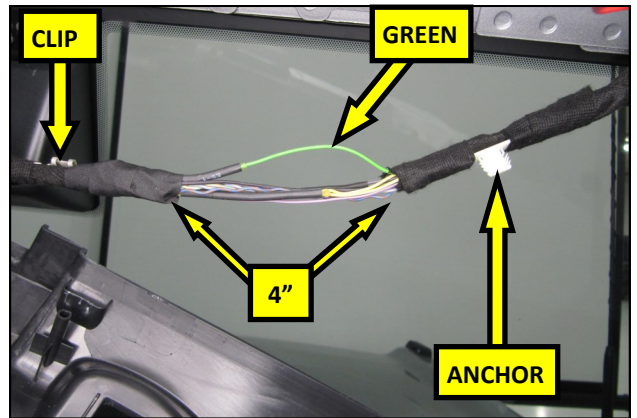

**20.** Unwrap approximately 4" of the OEM wire harness between the metal trim clip and the plastic anchor to expose the wires. Locate the Green wire and separate it from the other wires.

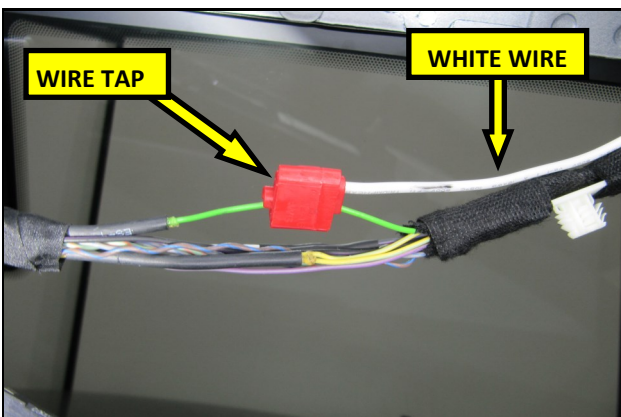

**21.** Using the supplied Wire Tap, connect the White RTR Pig Tail wire to the Green wire in the harness.

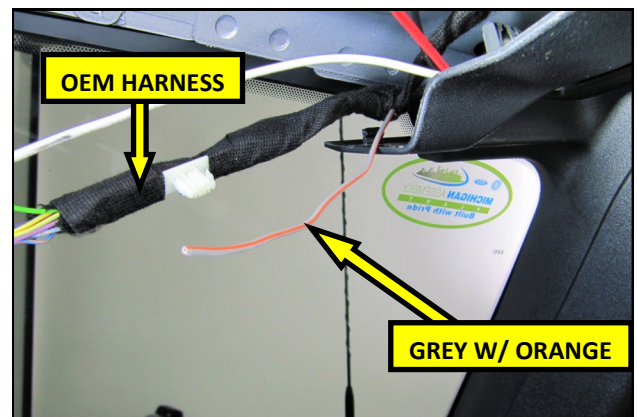

**22.** The Locate the Grey wire with the Orange tracer looped into the OEM harness and pull the free end out.

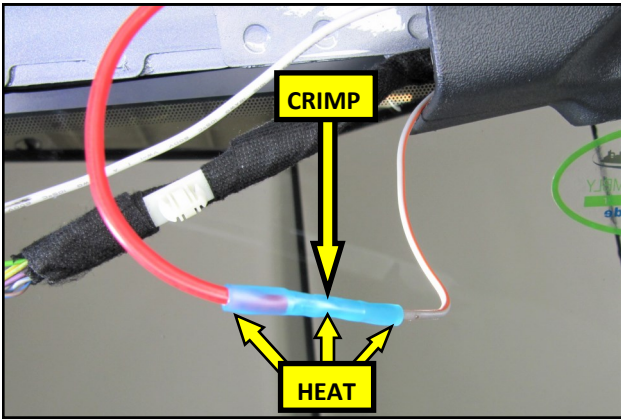

**23.** Strip approximately 3/16" of insulation from the Red wire in the RTR Pig Tail and from the Grey/Orange accessory wire and use the supplied Butt Connector to crimp the two together. Using a heat gun on low, shrink the insulation down onto the wires.

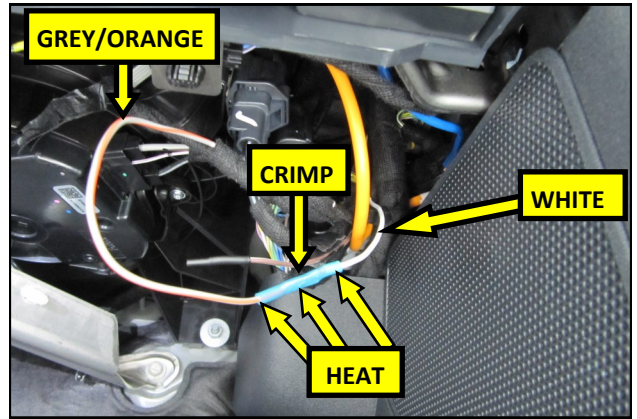

**24.** In the passenger side footwell, locate the other end of the Grey accessory wire with the Orange tracer looped into the OEM harness and pull the free end out. Locate the White accessory wire taped to the harness. Using the supplied Butt Connector- Strip, crimp and heat shrink the two wires together.

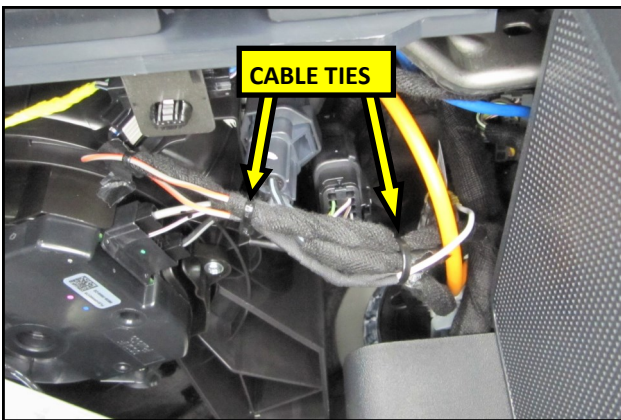

**25.** Secure the wiring in the passenger side footwell using the supplied Cable Ties.

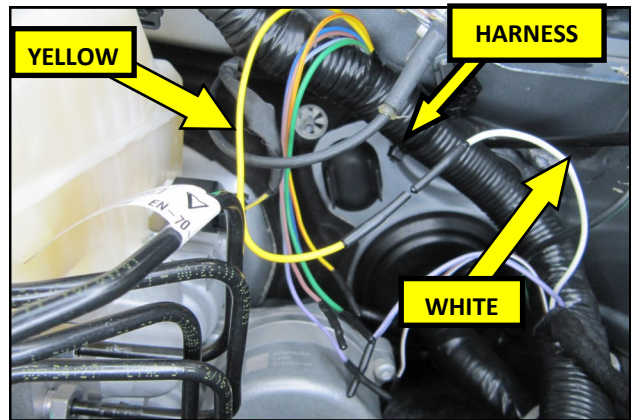

**26.** Under the hood, at the driver side firewall, locate the Yellow and white accessory wires taped to the OEM harness and unwrap them.

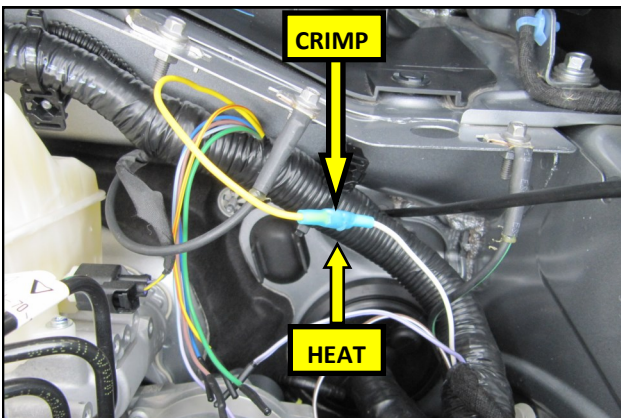

**27.** Using the supplied Butt Connector- Strip, crimp and heat shrink the two wires together. Secure the wires using the last Cable Tie. Use electrical tape to wrap the wires if needed.

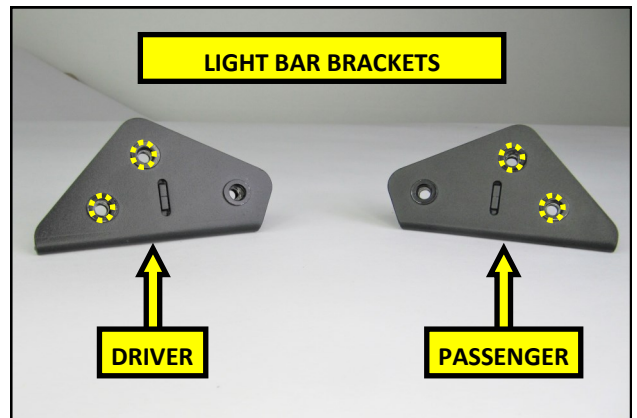

**28.** Locate and identify the Driver and Passenger side Light Bar Brackets.

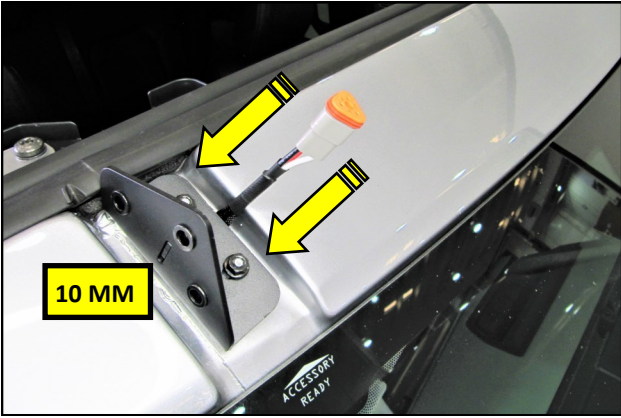

**29.** Install the Passenger side Light Bar Bracket onto the vehicle as shown, with the Connector half of the Pig Tail pointed towards the Drivers side of the vehicle. Secure the Bracket using the OEM nuts removed in step 2. Leave the nuts snug at this time.

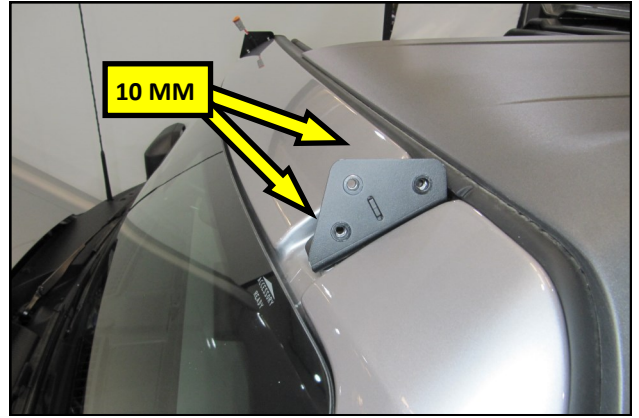

**30.** Install the Driver side Light Bar Bracket onto the vehicle as shown, using the OEM nuts removed in step 2. Leave the nuts snug at this time.

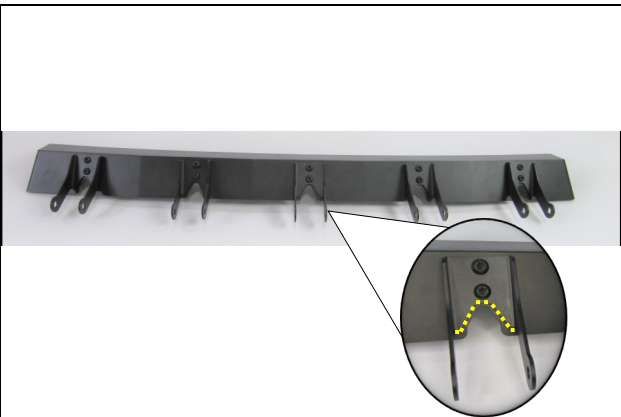

**31.** Using a T-40 TORX® driver and a 13mm wrench, mount the 5 Light Brackets to the Bar using the supplied 8 mm hardware.

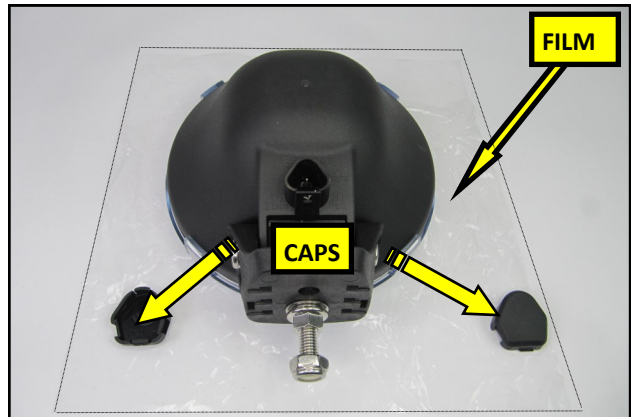

**32.** Unpack the Lights and remove the hardware caps from both the sides of the Light mount. Leave the protective film on the lens to prevent scratching.

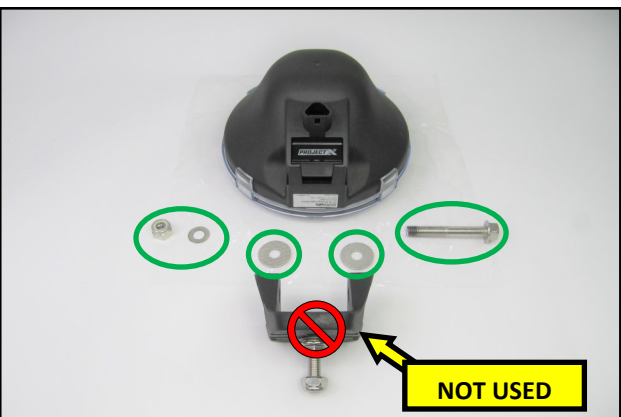

**33.** Disassemble the lights. Remove the hardware and mounting bracket. Set the bracket and short bolt aside. They will not be used with the RTR Light Bar.

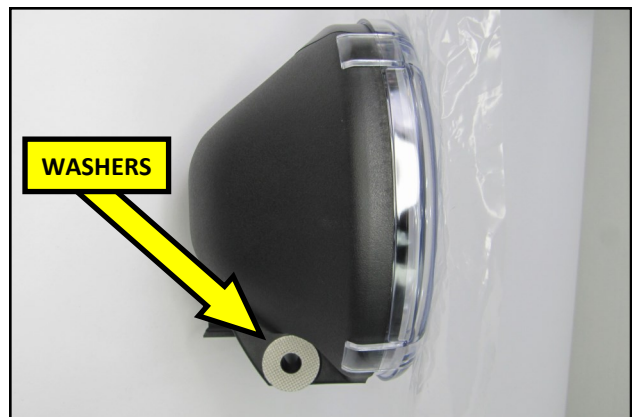

**34.** Transfer the Large grip washers into the pockets on both sides of the Light.

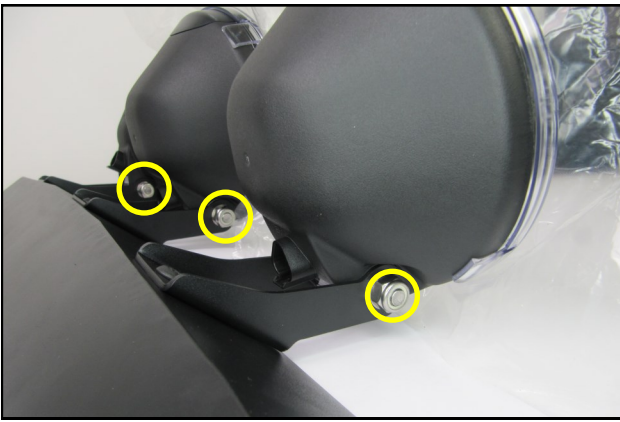

**35.** Slide the lights into the RTR Light Brackets as shown and secure them using the hardware removed in step 33. Leave the mounting hardware snug at this time.

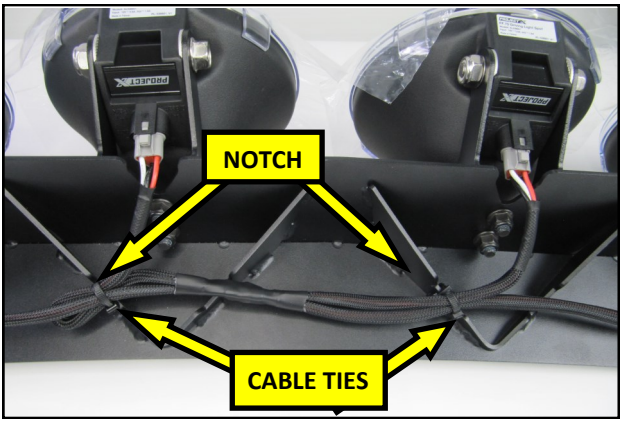

**37.** Secure the Harness to the Light Bar using the Edge Clip Cable Ties. Slide the clip into the notch in the Bar support and cinch the Tie down onto the Harness'. Trim the excess length.

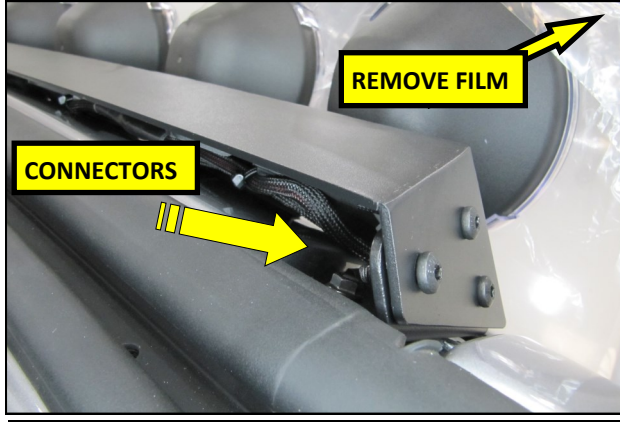

**39.** Connect the Light Bar Harness to the RTR Pig Tail and tuck it down underneath the light. Remove the protective film from the lenses.

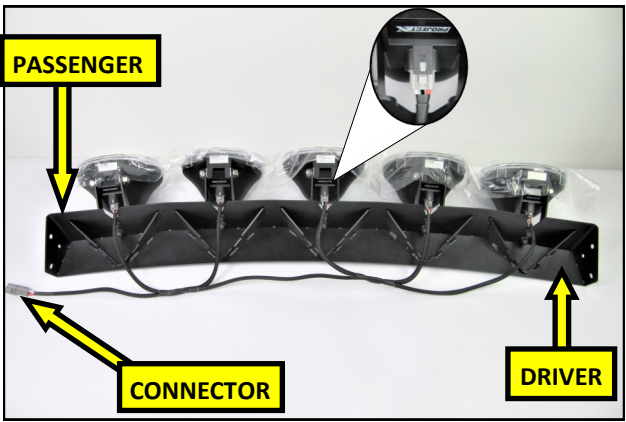

**36.** Turn the Light Bar assembly upside down on a protective work surface and connect the Harness to the Lights. When properly installed, the Connector will be on the Left with the Lights facing away.

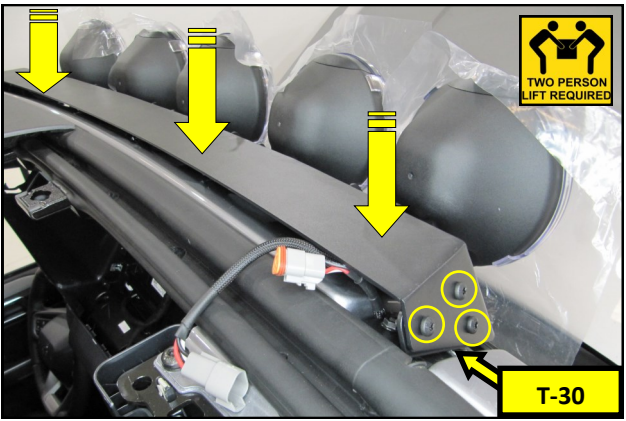

**38.** With the help of an assistant, lower the Light Bar assembly onto the Light Bar Brackets. Check the Wire Harness to roof clearance and reroute if necessary. Secure the Bar on each side using the 6mm Button Head Bolts. Leave the bolts snug for now.



**40.** Reconnect the Negative battery terminal and perform a function check. With the vehicle running or in accessory mode, the driving lights will be illuminated. With the engine running and the number one overhead accessory switch selected, the projecting lights will be illuminated.

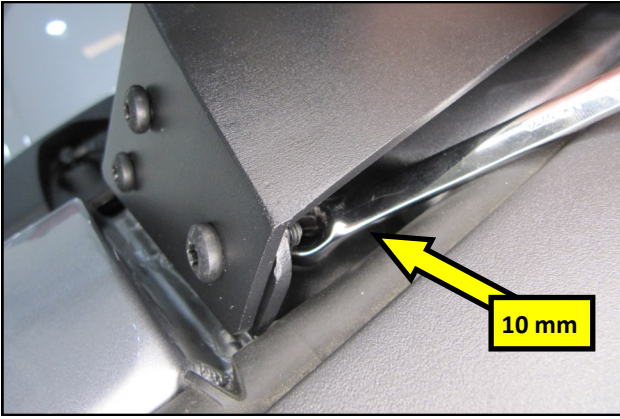

**41.** Using a 10mm wrench, tighten the 4 Bracket nuts from steps 29 and 30.

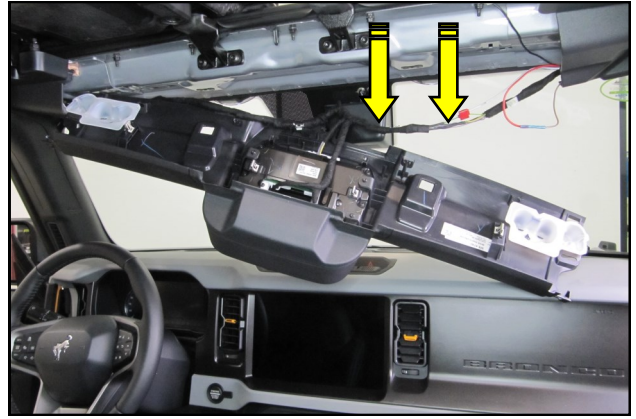

**42.** Reconnect the wiring harness to the windshield trim panel.



**43.** Reinstall the trim panels and check for any untucked wiring.



**44.** Reinstall the visor clips removed in step 7. Do not over tighten.

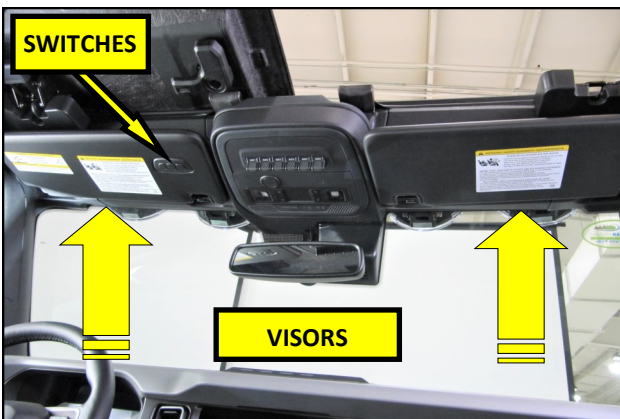

**45.** Reinstall the visors removed in step 5. **NOTE:** The Driver side visor has the 3 button switch panel.

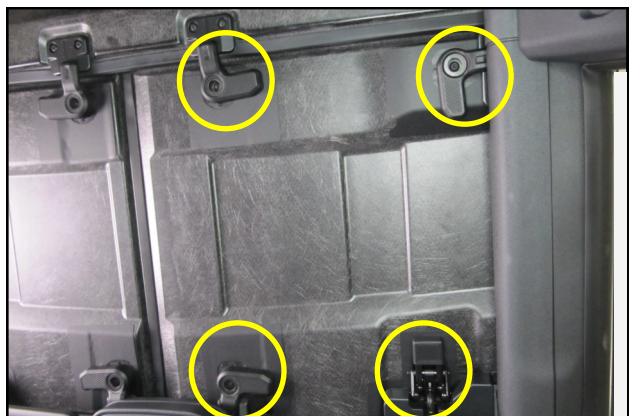

**46.** Fold the soft top forward or reinstall the hard top panel and fasten the latches or turn handles.



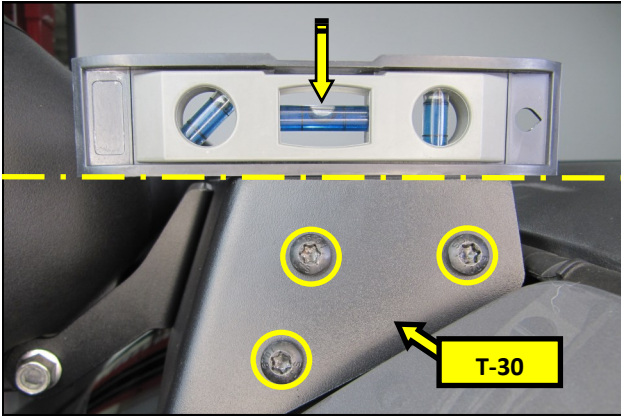

**47.** With the vehicle parked on level ground, place a level on the top of the Light Bar as shown. Adjust the angle of the Light Bar as needed to get it parallel to the ground. Tighten all six light Bar screws, final tight.

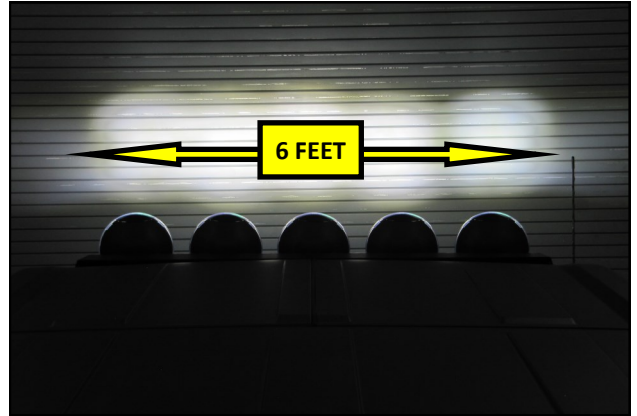

**48.** With the vehicle parked on level ground, 10 feet from a vertical wall, adjust the lights to the desired beam pattern and tighten the bolts final tight. RTR recommends starting by adjusting the center of the beams to a height of 6 feet. **NOTE:** Tire size and suspension options will have an effect on this measurement.

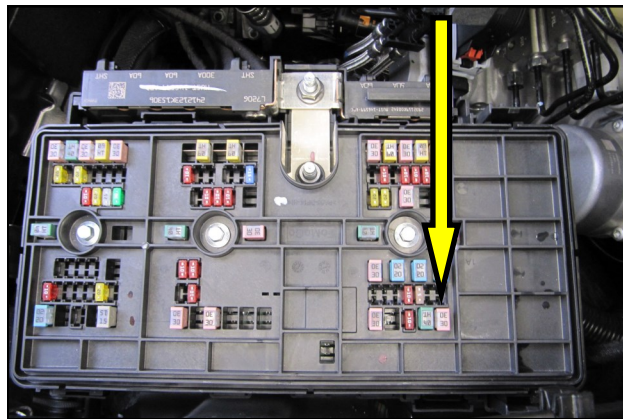

**49. NOTE:** The number 60, 30 amp fuse in the under hood fuse box protects the light Bar circuit.

NOTE: The replacement fuse for the Light Bar circuit is **Littelfuse® (MCAS030.XP) MCASE Pink 32V 30 Amp Fuse**

**THIS PAGE HAS INTENTIONALLY BEEN LEFT BLANK**