

2021+ Bronco High Clearance Exhaust System

Installation Instructions
P/N: 422234 (1521-5230)

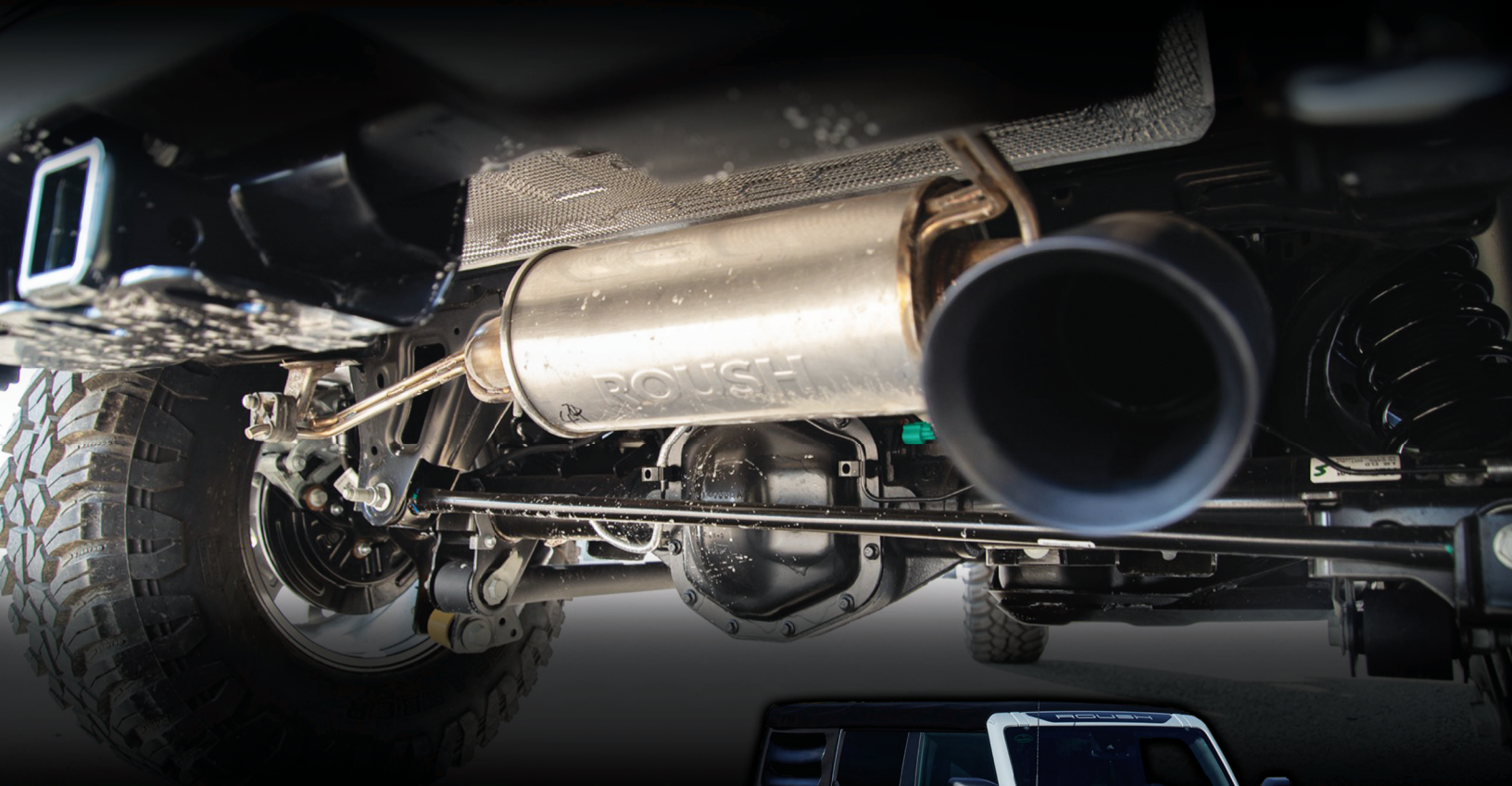

ROUSH
PERFORMANCE

12170 Globe St., Livonia, MI 48150 | [800.59.ROUSH](tel:80059ROUSH)

2021+ Bronco High Clearance Exhaust System

Installation Instructions

P/N: 422234 (1521-5230)



Application: 2021+ Bronco 2.3/2.7L

Important Note:

Before installing your ROUSH Performance Product(s), read through the entire installation procedure and check to make sure all items are present. Contact ROUSH Customer Service at 1-800-59-ROUSH, weekdays from 9:00 AM to 5:00 PM EST, with any questions regarding fit, missing parts or instructions that are unclear to you.

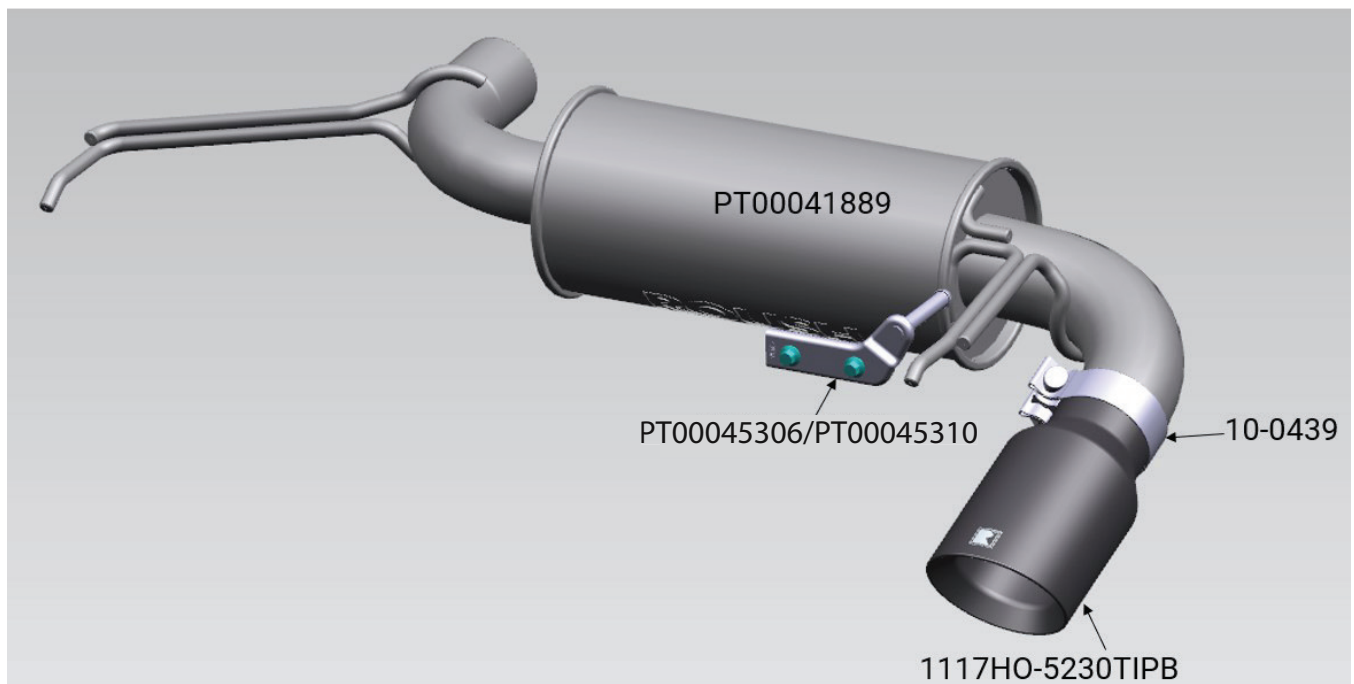

TABLE OF CONTENTS

Packing List for 2021+ Bronco High Clearance Exhaust System 3
Equipment and Supplies Required 4
Limit of Liability Statement..... 4
Safety Precautions 4
Work Safely!..... 4
Section A – Removal 5
Section B – Installation 6

PACKING LIST FOR 2021+ BRONCO HIGH CLEARANCE EXHAUST SYSTEM

Description	Part Number	Quantity
High Clearance Exhaust System	422233 (1521-5230)	
Muffler Assembly	PT00041889	1
3" Exhaust Clamp	10-0439	1
2.3L Bronco Exhaust Hanger	PT00045306/PT00045310	1
3" Black Coated Exhaust Tip w/Etching	1117HO-5230TIPB	1
Customer Care Kit	RETAIL DOC	1



EQUIPMENT AND SUPPLIES REQUIRED

- 15 mm + 13 mm Socket Deep Well with Ratchet
- Torque Wrench for Sockets
- Soapy Water
- General Automotive Tools (Pliers, Needle Nose, etc.)

If you are missing any items, please call us toll free at 800-597-6274.

LIMIT OF LIABILITY STATEMENT

The information contained in this publication was accurate and in effect at the time the publication was approved for printing and is subject to change without notice or liability. ROUSH Performance Products (RPP) reserves the right to revise the information presented herein or to discontinue the production of parts described at any time.

SAFETY PRECAUTIONS



CAREFULLY READ THE IMPORTANT SAFETY PRECAUTIONS and WARNINGS BEFORE PROCEEDING WITH THE INSTALLATION!

Appropriate disassembly, assembly methods and procedures are essential to ensure the personal safety of the individual performing the kit installation. Improper installation due to the failure to correctly follow these instructions could cause personal injury or death. Read each step of the installation manual carefully before starting the installation.

- Always wear safety glasses for eye protection.
- Place ignition switch in the OFF position.
- Always apply the parking brake when working on a vehicle.
- Block the front and rear tire surface to prevent unexpected vehicle movement.
- If working with a lift, always consult vehicle manual for correct lifting specifications.
- Operate the engine only in well-ventilated areas to avoid exposure to carbon monoxide.
- Do not smoke or use flammable items near or around the fuel system.
- Use chemicals and cleaners in well-ventilated areas.
- Batteries produce explosive gases, which can cause personal injury. Therefore, do not allow flames, sparks or flammable substances to come near the battery.
- Keeps hands and any other objects away from the radiator fan blades.
- Keep yourself and your clothing away from moving parts when the engine is running.
- Do not wear loose clothing or jewelry that can get caught in rotating parts or scratch surface finishes.
- Allow the engine, cooling system, brakes and exhaust to cool before working on a vehicle.

WORK SAFELY!

Perform this installation on a good clean level surface for maximum safety and with the engine turned off.

SECTION A – REMOVAL

The following section will guide you through the disassembly of the stock components. Special care should be taken to label fasteners and parts that are taken off during this procedure since many will be reused.

1. Be sure to allow the vehicle exhaust system to cool before beginning the removal process so that the components are cool to the touch.
2. Using a 15 mm socket, loosen the band clamp just behind the rear frame member.

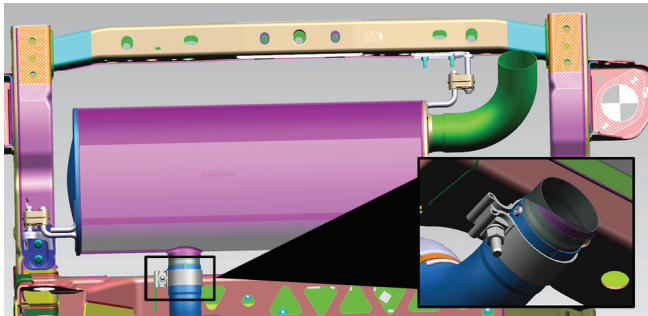

3. Spray exhaust hangers with soapy water and slide off the hanger isolator. Remove the muffler from the vehicle.

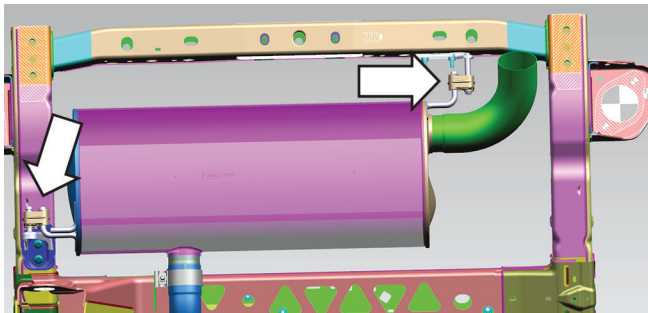

4. Unplug the rear bumper wiring harness, if equipped, on both sides of the vehicle just below the taillight at the edge of the bumper.

5. On both sides, remove the bolt shown used to adjust the bumper. (Torque to 27 Nm.)

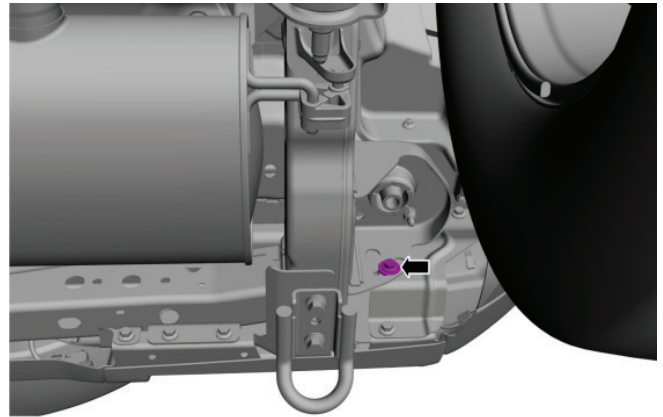

6. Remove the four (4) tow hook bolts and remove the rear bumper cover. (Torque to 80 Nm.)

NOTE: Some vehicles may only have one tow hook.

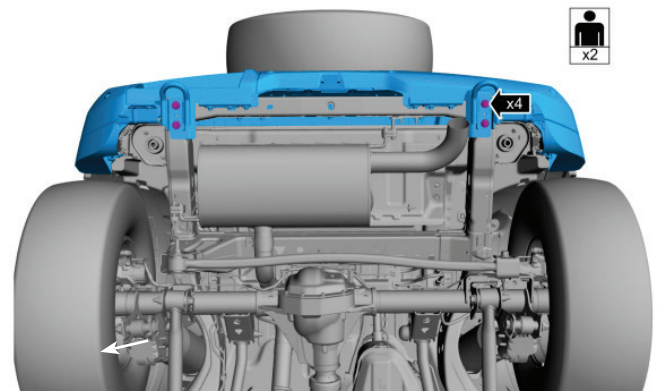

7. **2.3L:** Loosen the two (2) 13 mm nuts from the rear exhaust hanger. Remove the exhaust hanger, flip 180 degrees and reinstall. Retighten the nuts to 35 Nm.

2.7L: Loosen the two (2) 13 mm nuts from the rear exhaust hanger. Remove the exhaust hanger, install provided hanger PN: PT00045306 and PT00045310 as shown. (Install the spacer against the frame and hanger on top.)

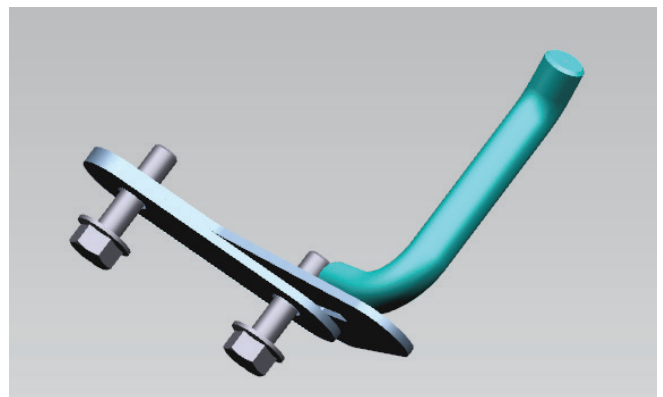

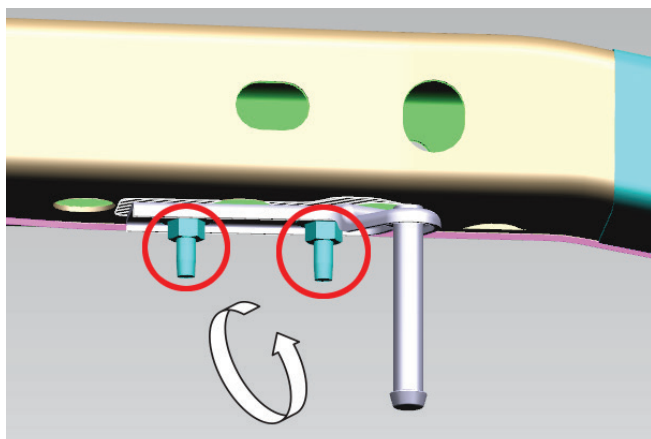

8. Reinstall the bumper reversing steps 4-6.

SECTION B – INSTALLATION

1. Slide the exhaust hanger isolators onto the factory mounts removed previously.
2. Install the ROUSH muffler onto the vehicle.
3. Install the ROUSH exhaust tip (1117HO-5230TIPB) and clamp (10-0439) onto the muffler. Hand tighten with the logo facing up just so you can still rotate tip.

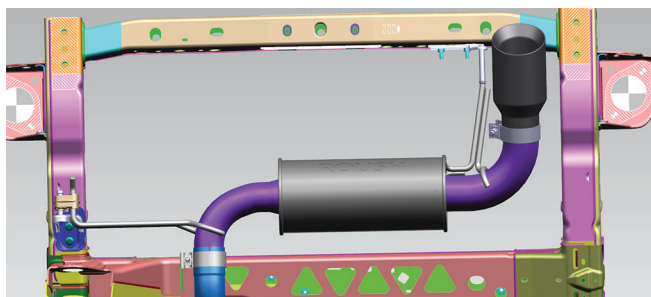

4. Tighten the exhaust clamp first at the overaxle portion to 55 Nm.
5. Tighten the exhaust clamp at tip last. Be sure to orient the tip with the ROUSH logo facing up. Torque to 55 Nm.
6. Start the vehicle and check for exhaust leaks. If leaks are present, make sure the exhaust system is fully inserted into the vehicle. Re-tighten the clamps to 55 Nm.

NOTE: There is a small drain hole on the muffler. Disregard this drain hole during the leak check, as some exhaust will be seen coming from this drain hole.